

International
IR Rectifier

MBR735/ MBR745
 MBRB735/ MBRB745

SCHOTTKY RECTIFIER

7.5 Amp

Major Ratings and Characteristics

Characteristics	Values	Units
$I_{F(AV)}$ Rectangular waveform	7.5	A
V_{RRM}	35/45	V
I_{FSM} @ $t_p = 5 \mu s$ sine	690	A
V_F @ 7.5Apk, $T_J = 125^\circ C$	0.57	V
T_J range	- 65 to 150	$^\circ C$

Description/Features

The MBR7. Schottky rectifier has been optimized for low reverse leakage at high temperature. The proprietary barrier technology allows for reliable operation up to $150^\circ C$ junction temperature. Typical applications are in switching power supplies, converters, free-wheeling diodes, and reverse battery protection.

- $150^\circ C T_J$ operation
- High purity, high temperature epoxy encapsulation for enhanced mechanical strength and moisture resistance
- High frequency operation
- Guard ring for enhanced ruggedness and long term reliability

Case Styles

MBR735/ MBR745

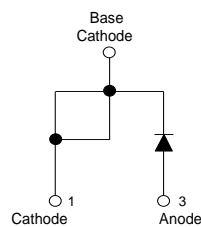

TO-220AC

MBRB735/ MBRB745

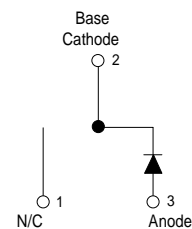
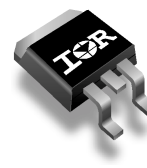

D²PAK

Voltage Ratings

Parameters	MBR.735	MBR.745
V _R Max. DC Reverse Voltage (V)	35	45
V _{RRM} Max. Working Peak Reverse Voltage (V)		

Absolute Maximum Ratings

Parameters	MBR..	Units	Conditions
I _{F(AV)} Max. Average Forward Current	7.5	A	@ T _C = 131 °C (Rated V _R)
I _{FSM} Non-Repetitive Peak Surge Current	690	A	5µs Sine or 3µs Rect. pulse Surge applied at rated load condition halfwave single phase 60Hz
	150		
I _{RRM} Peak Repetitive Reverse Surge Current	1.0	A	2.0 µsec 1.0 KHz

Electrical Specifications

Parameters	MBR..	Units	Conditions
V _{FM} Max. Forward Voltage Drop (1)	0.84	V	@ 15A T _J = 25 °C
	0.57	V	@ 7.5A T _J = 125 °C
	0.72	V	@ 15A
I _{RM} Max. Instantaneous Reverse Current (1)	0.1	mA	T _J = 25 °C Rated DC voltage
	15	mA	T _J = 125 °C
C _T Max. Junction Capacitance	400	pF	V _R = 5V _{DC} , (test signal range 100Khz to 1Mhz) 25°C
L _S Typical Series Inductance	8.0	nH	Measured from top of terminal to mounting plane
dv/dt Max. Voltage Rate of Change (Rated V _R)	1000	V/ µs	

(1) Pulse Width < 300µs, Duty Cycle <2%

Thermal-Mechanical Specifications

Parameters	MBR..	Units	Conditions
T _J Max. Junction Temperature Range	-65 to 150	°C	
T _{stg} Max. Storage Temperature Range	-65 to 175	°C	
R _{thJC} Max. Thermal Resistance Junction to Case	3.0	°C/W	DC operation
R _{thCS} Typical Thermal Resistance, Case to Heatsink	0.50	°C/W	Mounting surface, smooth and greased
wt Approximate Weight	2(0.07)	g(oz.)	
T Mounting Torque	Min. 6(5)	Kg-cm (lbf-in)	
	Max. 12(10)		

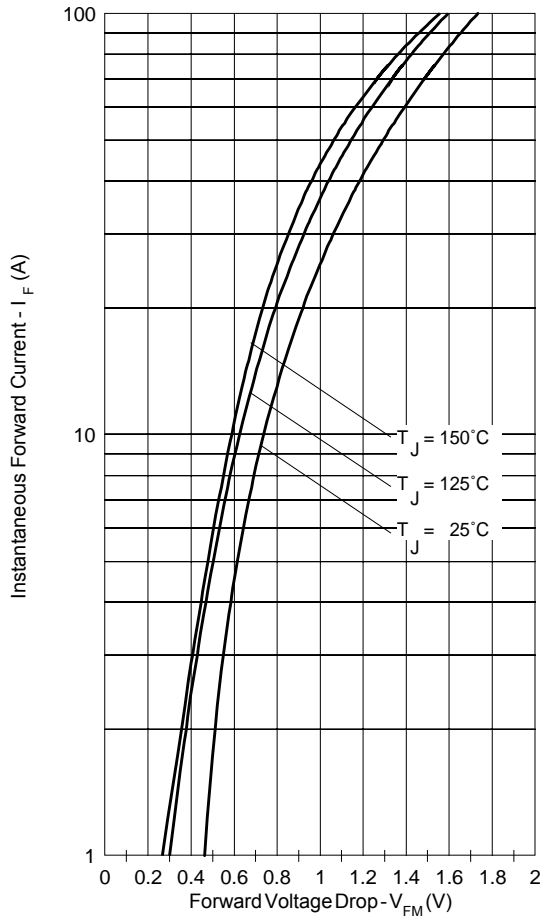

Fig. 1 - Max. Forward Voltage Drop Characteristics (Per Leg)

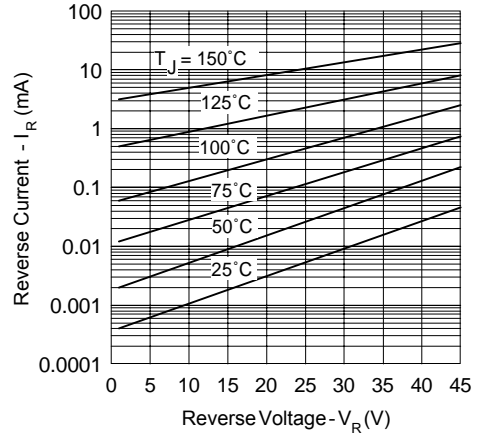

Fig. 2 - Typical Values Of Reverse Current Vs. Reverse Voltage (Per Leg)

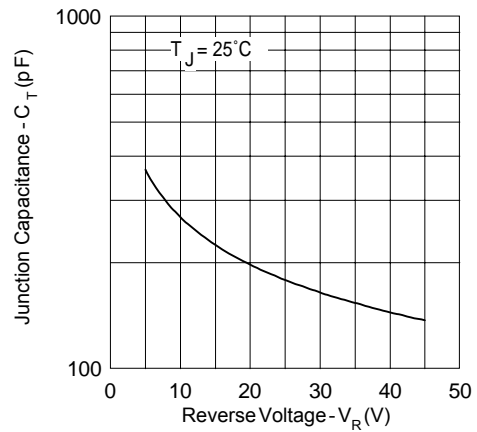

Fig. 3 - Typical Junction Capacitance Vs. Reverse Voltage (Per Leg)

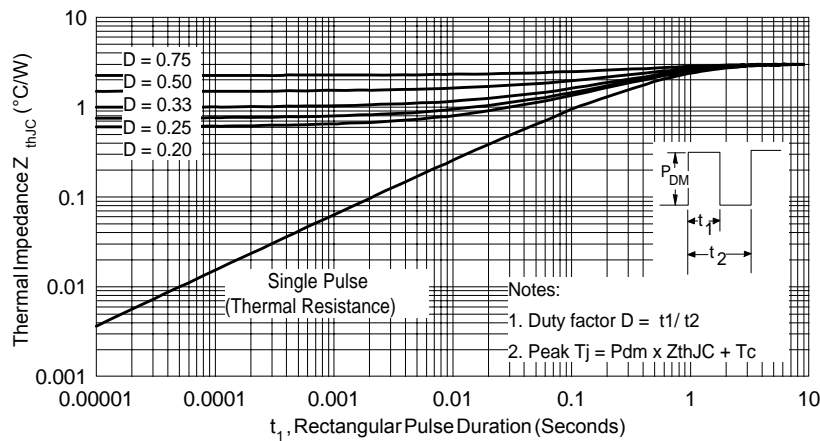

Fig. 4 - Max. Thermal Impedance Z_{thJC} Characteristics (Per Leg)

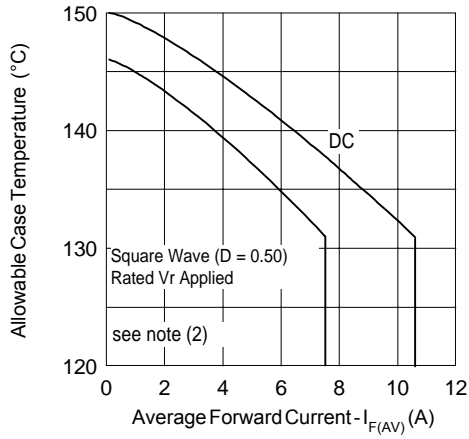

Fig. 5 - Max. Allowable Case Temperature Vs. Average Forward Current

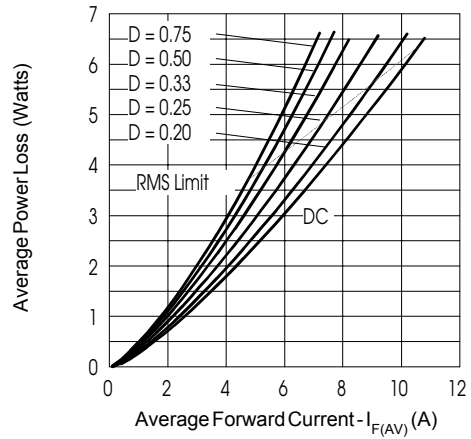

Fig. 6 - Forward Power Loss Characteristics

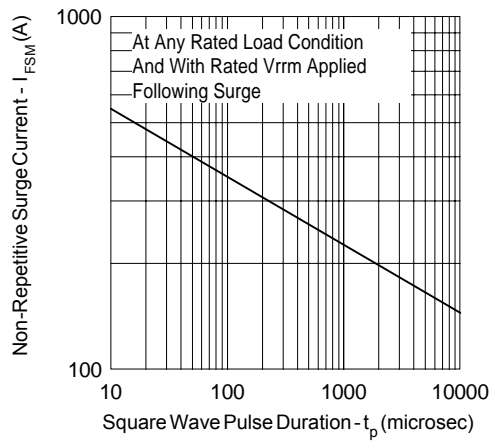
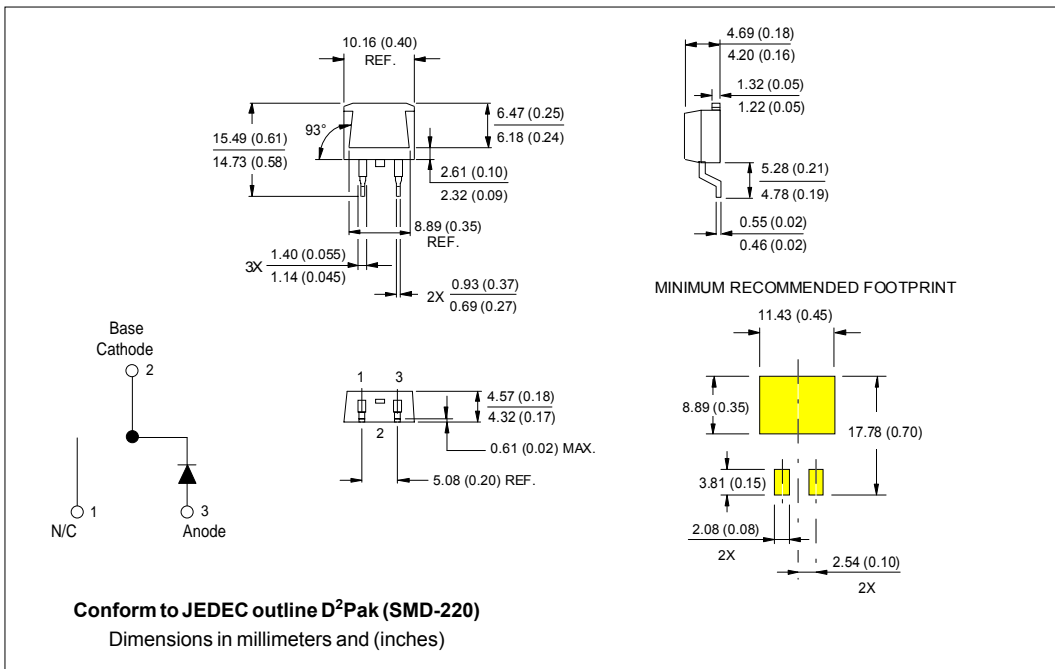
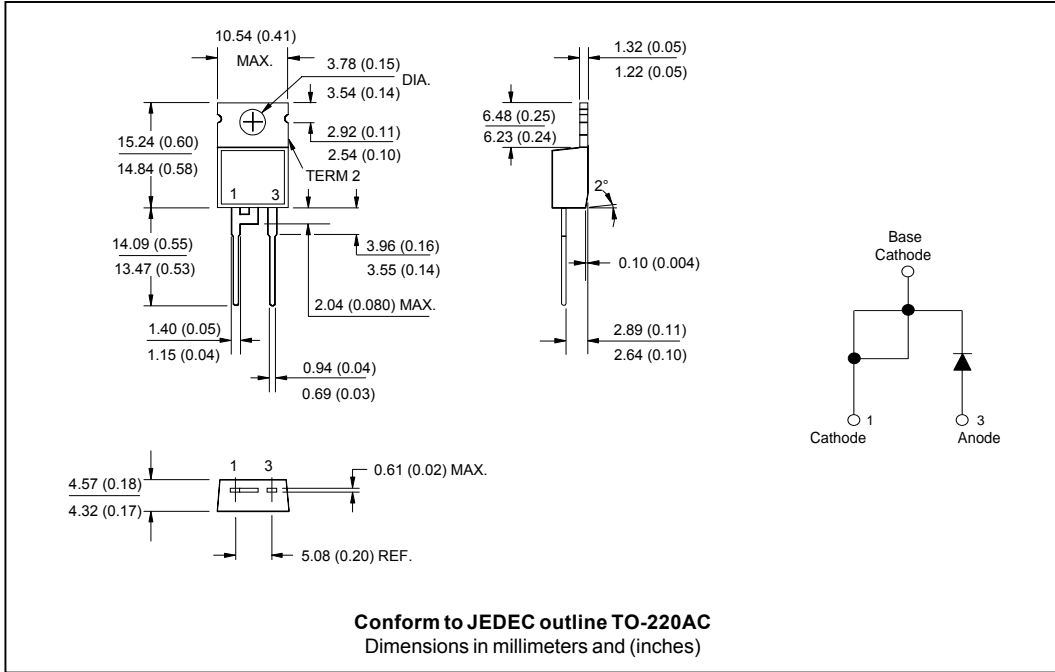

Fig. 7 - Max. Non-Repetitive Surge Current (Per Leg)

- (2) Formula used: $T_c = T_j - (Pd + Pd_{REV}) \times R_{thJC}$;
 Pd = Forward Power Loss = $I_{F(AV)} \times V_{FM} @ (I_{F(AV)} / D)$ (see Fig. 6);
 Pd_{REV} = Inverse Power Loss = $V_{R1} \times I_R (1 - D)$; $I_R @ V_{R1}$ = rated V_R

Outline Table



Tape & Reel Information

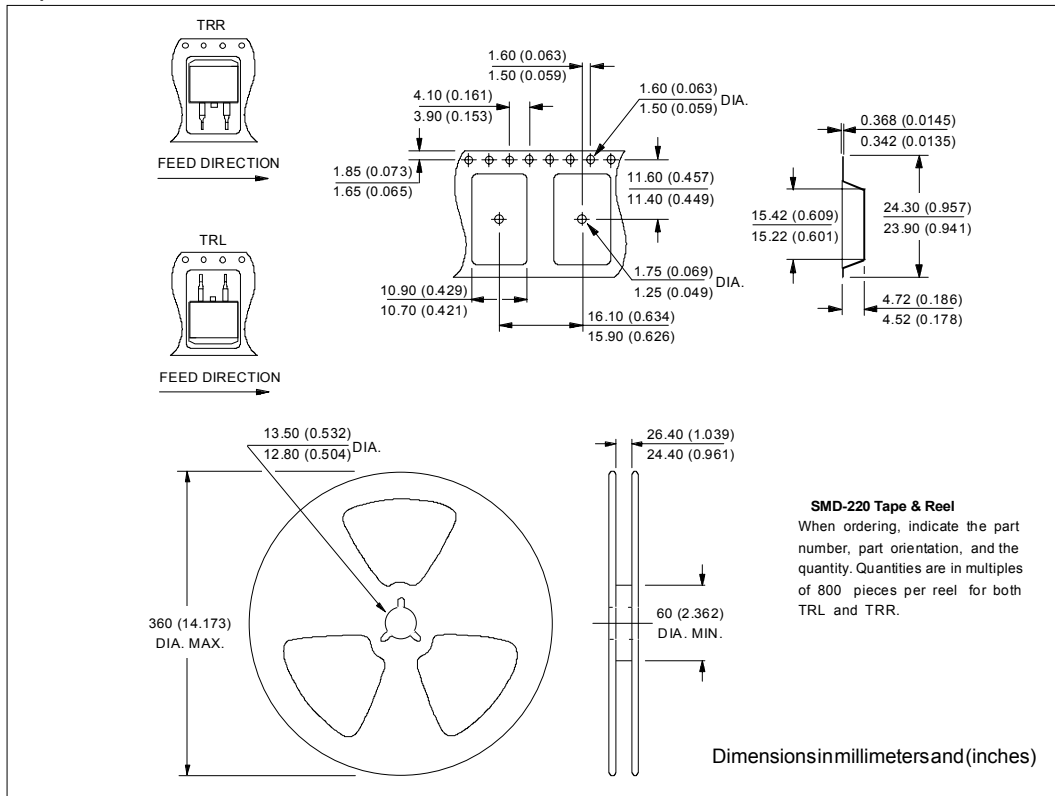

Ordering Information Table

Device Code			
MBR	B	7	45
①	②	③	④
1	- Essential Part Number		
2	- Package Style: none = TO-220 B = D ² Pak		
3	- Current Rating		
4	- Voltage Rating		35 = 35V 45 = 45V

```

MBR745
*****
* This model has been developed by *
* Wizard SPICE MODEL GENERATOR (1999) *
* (International Rectifier Corporation) *
* contains Proprietary Information *
*****
* SPICE Model Diode is composed by a *
* simple diode plus paralled VCG2T *
*****
.SUBCKT MBR745 ANO CAT
D1 ANO 1 DMOD (0.03191)
*Define diode model
.MODEL DMOD D(IS=9.72464638473799E-05A,N=1.30648926537753,BV=52V,
+IBV=0.195508065728349A,RS=0.000727548,CJO=1.94829876431799E-08,
+VJ=2.27282978121533,XTI=2,EG=0.854458710837653)
*****
*Implementation of VCG2T
VX 1 2 DC 0V
R1 2 CAT TRES 1E-6
.MODEL TRES RES(R=1,TC1=27.6281424524011)
GP1 ANO CAT VALUE={-ABS(I(VX))*(EXP(((((-5.219758E-03/27.62814)*(V(2,CAT)*1E6)/(I(VX)+1E-6)-
1))+1)*7.000165E-02*ABS(V(ANO,CAT))))-1)}
*****
.ENDS MBR745

Thermal Model Subcircuit
.SUBCKT MBR745 5 1

CTHERM1 5 4 1.05E+00
CTHERM2 4 3 4.44E+00
CTHERM3 3 2 1.16E+01
CTHERM4 2 1 6.12E+01

R THERM1 5 4 1.33E+00
R THERM2 4 3 1.19E+00
R THERM1 3 2 3.81E-01
R THERM1 2 1 9.54E-02

.ENDS MBR745

```

Data and specifications subject to change without notice.
This product has been designed and qualified for Industrial Level.
Qualification Standards can be found on IR's Web site.